

The study of air-plasma treatment on corn starch/poly(ϵ -caprolactone) films



G.A. Arolkar ^a, M.J. Salgo ^b, V. Kelkar-Mane ^b, R.R. Deshmukh ^{a,*}

^a Department of Physics, Institute of Chemical Technology, Matunga, Mumbai, 400 019, India

^b Department of Biotechnology, Mumbai University, Santacruz, Mumbai, 400 098, India

ARTICLE INFO

Article history:

Received 27 May 2015

Received in revised form

4 July 2015

Accepted 19 July 2015

Available online 20 July 2015

Keywords:

Corn starch/Poly(ϵ -caprolactone) (CSPCL)

Air-plasma treatment

XPS

Surface free energy

Barrier properties

Biodegradation

ABSTRACT

In spite of usefulness of synthetic polymers in every aspects of life, the environmental hazards limit their use. Starch based biodegradable polymers is one of the solutions to it. Packaging has a major share in use of synthetic polymers. For packaging application, it is necessary to have good surface and barrier properties of the material. Plasma surface modification of materials is a promising solution to enhance surface properties. In the present paper, cornstarch/poly(ϵ -caprolactone) (CSPCL) films were treated in air-plasma for different durations of time. The effect of air-plasma treatment on surface properties and biodegradation was studied. The extent of etching was evaluated from weight change (%) study. Changes in surface chemical composition were analyzed using ATR-FTIR and XPS. The contact angle and surface free energy (SFE) study indicate that air-plasma treatment leads to hydrophilization of CSPCL films. The changes in surface topography of plasma processed films were analyzed using AFM and SEM. The roughness caused by etching and increase in surface free energy facilitates the improvement in adhesive properties like printability and peel strength. Changes in barrier properties were studied using water vapor and oxygen transmission rate. Effect of air-plasma treatment on biodegradation of treated and untreated samples was studied by simulating natural biodegradation conditions in a controlled environment using indoor soil burial method and with a single bacterial system comprising of a commonly occurring soil bacterium, *Bacillus subtilis* MTCC 121. While the soil system is indicative of biodegradation due to macro as well as micro elements, a single microbial system will identify the interaction between the microorganisms and modified surface thus showing the effect of air-plasma treatment on the degradation process. Biodegradation by indoor soil burial method was assessed by measuring loss in tensile properties and growth of soil micro flora on surface by optical light microscopy (OLM). Biodegradation by *B. subtilis* was assessed by measuring increase in its number along with the changes it brought about in the sample surface by optical light microscopy and SEM. It was observed that such surface modifications enhanced the biodegradation rate along with finding application in packaging field, thus providing a green solution for the increasing packaging utilization and addressing environmental concerns.

© 2015 Elsevier Ltd. All rights reserved.

1. Introduction

Synthetic polymers are useful in every aspects of life but their environmental hazards limit their use. Packaging industry has a major share in use of synthetic polymers. Packaging materials are used for relatively short term applications. Mindset of 'use and throw' of synthetic polymers has created tremendous load on

* Corresponding author.

E-mail addresses: rr.deshmukh@ictmumbai.edu.in, rajadeshmukh@rediffmail.com (R.R. Deshmukh).

environment. Biodegradable polymers can provide solution to it. Number of biodegradable polymers were synthesized and studied for various applications in diverse fields [1,2]. Of them, starch-based biodegradable polymers are of greater interest. Starch is a natural biopolymer and in synthetic biodegradable polymer, Poly(ϵ -caprolactone) (PCL) has inherent biodegradability [3], good mechanical properties, compatibility with other polymers [4], hydrophobic nature, and easy availability. Starch and PCL blends, possessing comparable properties, were synthesized and studied by various researchers [5–10] to provide an environmental friendly substitute for currently used synthetic and non-degrading polymers.

The use of biodegradable polymers as packaging material has been initiated [11]. For packaging application, it is necessary that the polymer should have good surface and barrier properties. Various techniques such as, chemical treatment, UV irradiation, corona, plasma treatment, etc. have been employed for surface modification of polymers and textiles [12–14]. Surface modification of biodegradable polymers using UV radiation, chemical methods, plasma, etc. has been reported [15–18]. The plasma surface modification of polymers has an edge over other techniques as it alters top few angstroms of sample retaining its bulk properties. Use of reactive and non-reactive gases for plasma surface modification of polymers has been employed by our group to enhance surface properties [19,20]. Plasma surface modification of biodegradable polymers like chitosan, PLA, PCL, etc. has been reported in the medical field to improve biocompatibility [21–24] and to enhance interlayer interaction between cellulose nanofibre and PAA grafted PLLA film [25]. Zhang et al. [26] reported enzymatic degradability of polyhydroxyalkanoate films modified by argon plasma followed by acrylic acid grafting. Recently surface modification of PLA using atmospheric air-plasma has been investigated for improving adhesion properties [27] and for food packaging applications [28]. However, plasma surface modification of starch-PCL composite films is not explored much.

In present paper, air-plasma treatment was given to cornstarch/poly(ϵ -caprolactone) (CSPCL) films for different duration of time. The effect of air-plasma treatment on CSPCL films were evaluated with respect to chemical composition, surface morphology, wettability, adhesion properties and barrier properties. The effect surface modification on biodegradation behavior of CSPCL films was studied by indoor soil burial method as well as using a single bacterial *Bacillus subtilis* MTCC 121 (BS 121).

2. Experimental

2.1. Materials and chemicals

CSPCL polymer films (supplied by EarthSoul India) having thickness 30 μm were used in the present investigation. The CSPCL films used in this study have 30% starch, 65% PCL and 5% other materials as additives. Prior to plasma processing, films were sonicated in distilled water for 3 min followed by air drying at room temperature and stored in desiccator until use. Analytical Reagent (AR) grade chemicals such as Glycerol (G), Formamide (F), Ethylene Glycol (E), Di-iodomethane (D) were purchased from SD Fine-Chem Limited (India). Ink (SACHIN Sky Blue) used for printability study was manufactured by Hindustan Inks and Resins.

2.2. Plasma processing

Plasma reactor made of a glass tube having thickness 4 mm, height 120 mm and internal diameter 300 mm was used for this purpose. The diameter and distance between two electrodes was 20 cm and 2.5 cm respectively. Samples were kept between the electrodes on the quartz stand. Electrodes were capacitively coupled to Radio Frequency power supply ($\nu = 13.56$ MHz), as shown in Fig. 1. The system was evacuated to 0.001 mbar using Edward rotary vacuum pump. Air was purged three times and working pressure was adjusted to 0.15 mbar. A stable glow discharge of air was created at 40 W power. The plasma treatment was carried out for 0.5, 1, 2, 3 and 5 min on CSPCL films.

2.3. Characterization methods

The extent of etching due to air-plasma treatment was characterized by weight change (%) using METLER AE240 weighing

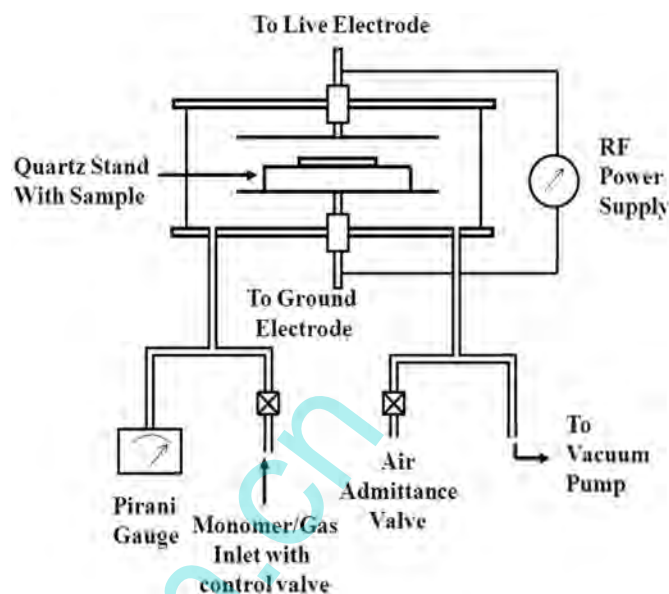

Fig. 1. Schematics of plasma reactor.

balance. The weight change (%) calculated using following formula

$$\% \text{ weight change} = \frac{W - W_0}{W_0} \times 100 \quad (1)$$

where W_0 and W is the weight of sample before and after plasma treatment respectively.

The chemical composition of samples was characterized using ATR-FTIR (Shimadzu, FTIR 8400s Spectrophotometer) and XPS (Omicron Surface Science instruments with EAC2000-125 energy analyzer). ATR-FTIR spectra were recorded in the range of 4000 cm^{-1} – 650 cm^{-1} with 64 scans having resolution of 4 cm^{-1} . XPS instrument having X-ray source Al $K\alpha$ at 1486.6 eV was used. The C1s envelope was analyzed and peak-fitted using a combination of Gaussian and Lorentzian peak shapes using the XPSPEAK41 software.

The change in surface free energy (SFE) i.e. degree of hydrophilicity was evaluated from contact angle (CA) measurements carried out with respect to various probe liquids such as distilled water (W), glycerol (G), Formamide (F), ethylene glycol (E) and di-iodomethane (D) using sessile drop method. CA was calculated from formula

$$\theta = 2 \tan^{-1} \left(\frac{h}{r} \right) \quad (2)$$

where θ = CA of given liquid on sample surface, h = height of the drop of liquid and r = half the base length of drop. For each sample, with each liquid 10 readings were taken. The SFE was calculated using Fowkes method extended by Owen and Wendt [29–33], using following Equation (3)

$$\left[\frac{1 + \cos\theta}{2} \right] \times \left[\frac{\gamma_l}{\sqrt{\gamma_l^d}} \right] = \sqrt{\gamma_s^p} \times \sqrt{\frac{\gamma_l^p}{\gamma_l^d}} + \sqrt{\gamma_s^d} \quad (3)$$

where γ_l^p , γ_l^d , γ_s^p , γ_s^d are polar and dispersion component of SFE of liquid and solid respectively and $\gamma_l = \gamma_l^p + \gamma_l^d$ is total SFE of liquid. To study effect of ageing, samples were stored in dry conditions in

desiccator and CA was measured at every 7 days.

The surface morphology of samples was studied using AFM (Benyuan Co. Ltd CSPM4000) and SEM (JEOL JSM 6380LA). AFM was used in tapping mode with horizontal and vertical resolution of 0.26 nm and 0.10 nm respectively. Samples for SEM were coated with gold using SPT sputter coater (JFC-1600 auto fine coater).

The improvement in adhesion properties of samples were studied from peel strength and % ink adhesion. A 180° T-peel test was carried out using Lloyd Instrument (model LR10Kplus) at a rate of 10 mm/min at room temperature. Peel strengths are reported as force of peel per unit width of adhesive joint. The % ink adhesion was calculated from modified cross-cut tape test. Printing ink having thickness 60 micron was applied on samples using bar applicator. The % of ink adhesion was defined in terms of % of ink remained on sample. Sample preparation for peel and printability test was done using modified ASTM 1876 and ASTM 3359 respectively as given elsewhere [19].

Barrier properties were studied with respect to water vapor and oxygen transmission. Water Vapor Transmission Rate was measured using desiccant method as per ASTM E96-95. Oxygen Transmission Rate was measured on Labthink, BTY-B1 as per ASTM D1434-82 pressure method. The test was performed with pressure difference of 0.1 MPa at 25 °C.

2.4. Biodegradation studies

Though, biodegradation is a bulk property of a material, its initiation starts at the site of microbial localization followed by their proliferation and colonization. Thus it is important to study the effect of air-plasma treatment on the surface of CSPCL films and consequently on the polymer degradation. Biodegradation of PCL containing polymer systems via soil burial method and bacterial degradation using *B. subtilis* has been reported by various researchers [34–39]. Degradation of polymers by indoor soil burial method simulates natural environment along with reproducibility and reliability of results [40]. Presence of variety of microbial flora and environmental parameters like humidity, temperature, etc. affect the degradation rate of polymers. To overcome these problems and to understand the effect of modification of surface properties on adhesion of microorganisms leading to degradation of CSPCL films, studies using a common soil bacterium *B. subtilis* MTCC 121 (BS 121) were performed. Bacillus spp. rod-shaped, sporulating, gram-positive bacterium is usually found in water, soil, air, as well as on decomposing plant residue. It is known to produce a variety of proteases and other enzymes that enable it to degrade a variety of polymers contributing to the nutrient cycling [41].

2.4.1. Biodegradation studies with indoor soil burial method

Strips of CSPCL polymer (9 cm × 1 cm) were buried between two layers (of thickness of 3 cm) of soil mixture in glass containers. The soil mixture contained garden soil and cow dung in a 2:1 ratio. Moisture content of the soil was maintained at 40–50% by periodical addition of water throughout the period of study and the temperature was maintained around 30 °C. The samples were retrieved after an incubation period of (7, 14, 28, 42 and 56 days). The samples were washed thoroughly using sterile distilled water, and used to study the degradation in terms of reduction in tensile properties {tensile strength (TS) and percent elongation at break (% Eb)} of the material over the period. Tensile properties were measured on Universal Testing Machine, Lloyd LR 10Kplus (with testing parameters, gauge length = 5 cm, width of sample = 1 cm, crosshead speed = 10 mm/min, Load cell = 100N). The samples were rinsed with distilled water and observed under 40× using Leica DM750, trinocular optical light microscope.

2.4.2. Biodegradation studies with BS 121

BS 121 was enriched in nutrient broth at 32 °C ± 2 °C for 24 h on shaker at 80 rpm. The media was then centrifuged in sterile tubes at 10,000 g for 20 min at 4 °C to obtain bacterial cell pellets. These were then washed and resuspended in sterile M9 minimal medium (HiMedia) so as to obtain a density of 10⁶ cell/ml. Since M9 minimal medium, does not have any carbon source, the CSPCL films (untreated and air-plasma treated) served as a sole source of carbon. CSPCL film without air-plasma treatment (untreated CSPCL) was used as a control. Each experiment was performed in duplicates. 1.5 ml M9 system with 10⁶ cell/ml of *B. subtilis* MTCC 121 and treated and untreated samples respectively were incubated at 32 °C ± 2 °C for 56 days. The biodegradation was evaluated using turbidimetric method. The turbidity was measured as Optical Density at 600 nm (OD600 nm) using Tecan M1000 spectrophotometer. Increase in turbidity was indicative of growth of BS 121 hence indicative of the degradation of the polymer. The degraded samples (washed with distilled water and 70% ethanol) were further analyzed under optical light microscope at 10× magnification for visual signs of bacterial colonization. The changes in morphology of sample surface were observed by SEM.

3. Results and discussion

3.1. Weight change (%)

The weight change (%) of air-plasma treated CSPCL films calculated from Equation (1) is shown in Fig. 2. Negative values imply loss of weight. With increase in air-plasma treatment time, weight change (%) decreases.

It is well known that weight loss process happens in two stages, first, removal of loosely bound low molecular weight fragments/oligomers, adsorbed species, etc. takes place, called as plasma cleaning. Secondly, etching of polymer surface layer by reactive plasma species (radicals, neutrals, energetic electrons, etc.) due to bond scission and degradation processes [42], called as ablation. In the discharge area, polymer was exposed to various reactive plasma species. With increasing treatment time, reactive species get more time to interact with polymer surface; this ultimately results in reduction in weight. Junkar et. al. observed that plasma treatment of semi-crystalline polymer had preferential etching of amorphous parts over crystalline parts [43]. Therefore it is possible that during short duration of plasma treatment

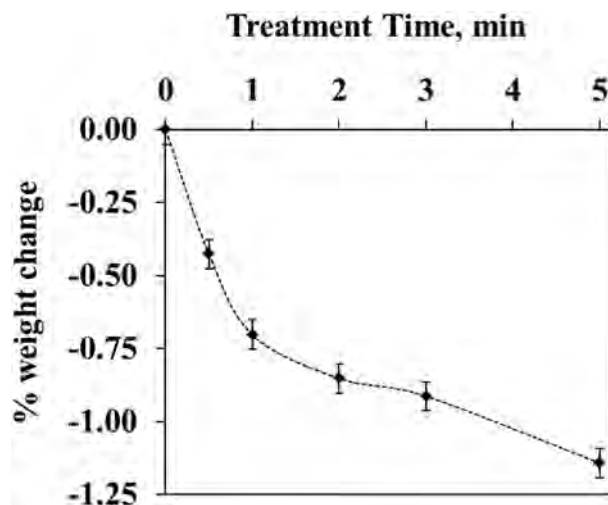

Fig. 2. Weight change (%) of air-plasma treated CSPCL films.

(0.5 min and 1 min), most of the etchable amorphous part get removed easily giving increasing weight loss. But with longer treatment time (2 min onwards), the tightly bound amorphous and crystalline part reduces the weight loss rate. The etched out material is subsequently pumped put.

3.2. Surface chemistry

The change in surface chemistry due to air-plasma treatment was analyzed using ATR-FTIR and XPS.

3.2.1. ATR-FTIR

Fig. 3 Shows ATR-FTIR spectra of untreated and air-plasma treated CSPCL films. Prominent peaks are listed in Table 1. The substantial increase in intensity of peaks 1, 4 and 5 indicates increase in oxygen containing groups (O–H group and C–O group) after the plasma treatment. These changes are possible due to interaction of oxygen related species present in air-plasma with substrate. Another possibility of incorporation of oxygen containing moieties onto the CSPCL films is due to the post plasma exposure of samples to the atmosphere. It has been reported that the treatment carried out in inert gases like argon introduces oxygen containing moieties onto the polymer surface because of post plasma exposure of samples to atmospheric oxygen [44]. The increase in C=O (peak 3) and C–H groups (peak 2, peak 6 and peak 7) can be correlated to relative increase in exposure of PCL component. To confirm this statement, ratio of PCL component (C=O bond at 1710 cm^{-1}) and starch component (C–O–C skeletal mode vibration of α -1,4 glycosidic linkage at 930 cm^{-1}) was calculated. The PCL to starch ratio for untreated, 2 min and 5 min air-plasma treated CSPCL found to be 5.96, 6.14 and 7.34 (giving 3.02% and 23.15% increase) respectively. This increasing ratio suggests loss of starch. Plasma treatment causes etching of polymer surface, exposing the backbone of polymer chains to the IR rays. In ATR-FTIR, the penetration depth is more (as compared to XPS), therefore increased peak intensity of peak 6 and peak 7 (i.e. CH₂ bending) was observed. Thus it can be concluded that air-plasma treatment resulted in incorporation of oxygen containing groups and removal of amorphous starchy phase.

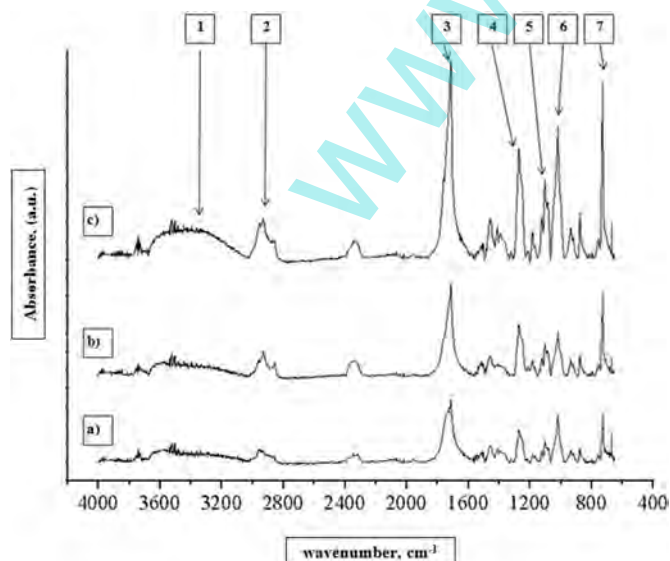

Fig. 3. ATR-FTIR spectra of CSPCL films a) untreated, b) 2 min air-plasma treated and c) 5 min air-plasma treated.

Table 1

Peak assignment in ATR-FTIR spectra of untreated and air-plasma treated CSPCL films.

Peak no.	Wavenumber, cm^{-1}	Peak assignment
1	3600–3000	O–H stretching
2	2947 and 2853	asymmetric and symmetric CH ₂ stretching respectively
3	1710	C=O stretching
4 & 5	1265, 1016	C–O stretching
6 & 7	725, 668	CH ₂ bending

3.2.2. XPS

To identify and quantify chemical composition of the air-plasma treated polymers, XPS was performed. The elemental composition was determined from survey scan. It was found that the atomic concentration of carbon decreases and that of oxygen increases with increase in treatment time as shown in Fig. 4.

Fig. 5 shows de-convoluted peaks of C1s spectra of untreated, 2 min and 5 min air-plasma treated CSPCL films. Peak assignments (from the chemical structures of starch and PCL [45]) and % area of de-convoluted C1s spectra are given in Table 2.

It was observed that the air-plasma treatment results in decrease in intensity of C1 peak indicating the decrease in carbeneous (C–C) content whereas increase in intensities of C2 and C3 peaks indicates that oxygen containing moieties are incorporated onto the CSPCL films. Contribution due to peak C4 essentially remains constant. These changes can be attributed to generation of oxygen containing species due to interaction of activated surface with oxygen-containing entities in plasma as well as post exposure of samples to the atmosphere. This incorporation of polar groups on the surfaces affects surface properties like wettability, adhesive strength of the surface as seen ahead.

3.3. Contact angle (CA) and surface free energy (SFE)

The surface of untreated CSPCL films is quite hydrophobic as seen from CA data for all the probe liquids as shown in Fig. 6. It was observed that with increase in treatment time, CA of all liquids decreases; indicating that surface is becoming hydrophilic or more wettable.

The SFE was calculated from CA data using Equation (3) and is shown in Table 3. The total SFE is the sum of polar and dispersion

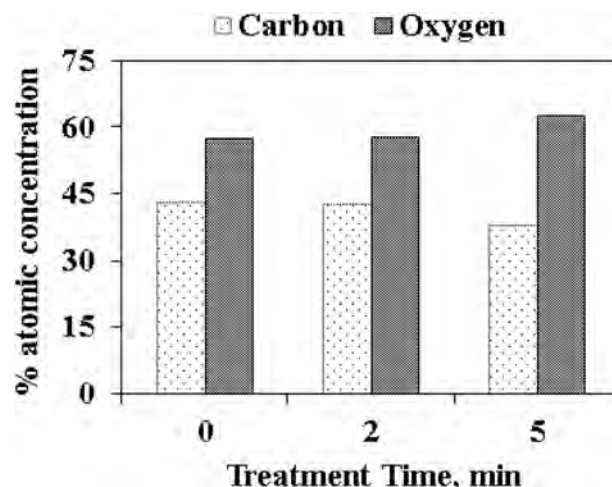

Fig. 4. % Atomic concentration of untreated and air-plasma treated CSPCL films.

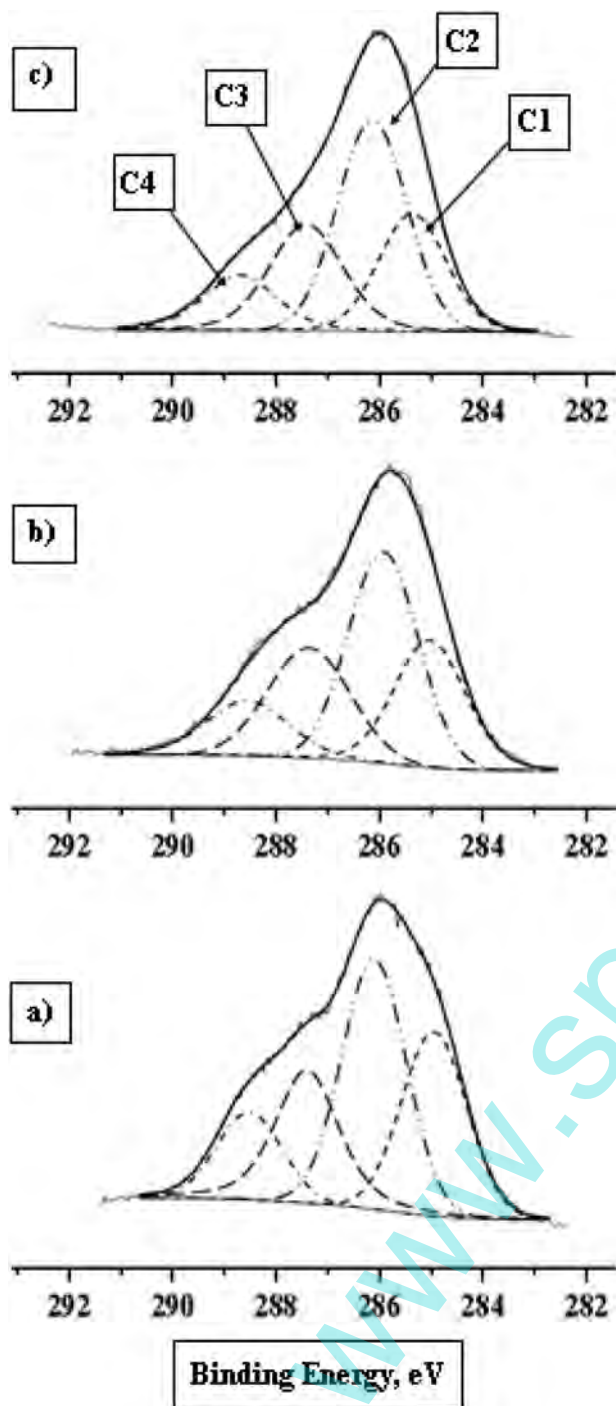

Fig. 5. C1s spectra of CSPCL films a) untreated, b) 2 min air-plasma treated and c) 5 min air-plasma treated.

components. The untreated CSPCL film has high dispersion component than that of polar component. It was observed that SFE increases with respect to treatment time with percentage increase in polar component is up to 95.25% and that of dispersion component is up to 48.83% giving 23.01% increase in polarity for 5 min air-plasma treatment.

The incorporation of oxygen containing moieties (polar functional groups) and the increase in surface roughness (increase in effective area, explained in next section) are responsible for decrease in CA. The incorporation of polar groups is in agreement with XPS results.

Table 2
Peak assignments and analysis of C1s spectra of untreated CSPCL and air-plasma treated CSPCL films.

BE (eV)	285.00	286.50	287.70	288.95
Peaks	C1	C2	C3	C4
Peak assignment	C–C or C–H	C–O	O–C–O	O = C–O
Relative Concentration				
Untreated CSPCL	27.37	36.86	22.84	12.93
2 min air-plasma	24.92	38.53	23.72	12.84
5 min air-plasma	22.82	40.39	24.04	12.76

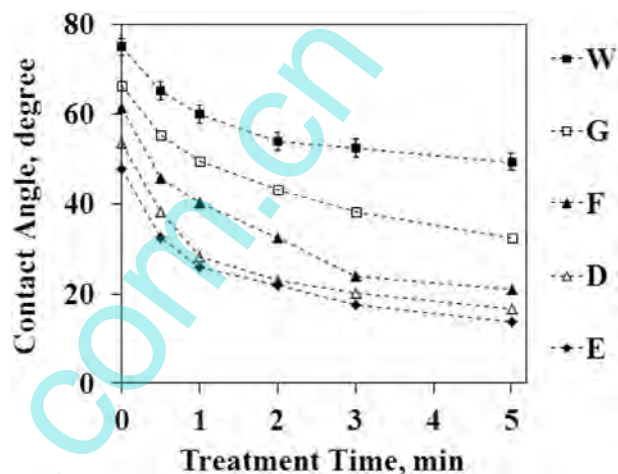

Fig. 6. Contact Angle of untreated and air-plasma treated CSPCL film.

Table 3
Polar component, Dispersion component and Total SFE of untreated and air-plasma treated CSPCL film.

Treatment time, min	Polar comp., (γ_s^p) mJ/m^2	Dispersion comp., (γ_s^d) mJ/m^2	Total SFE, (γ_s) mJ/m^2	Polarity $p = \gamma_s^p/\gamma_s$
0	7.37	28.12	35.48	0.208
0.5	9.48	34.42	43.90	0.216
1	10.41	38.42	48.83	0.213
2	12.73	39.73	52.21	0.244
3	13.18	41.27	54.45	0.242
5	14.39	41.85	56.24	0.256

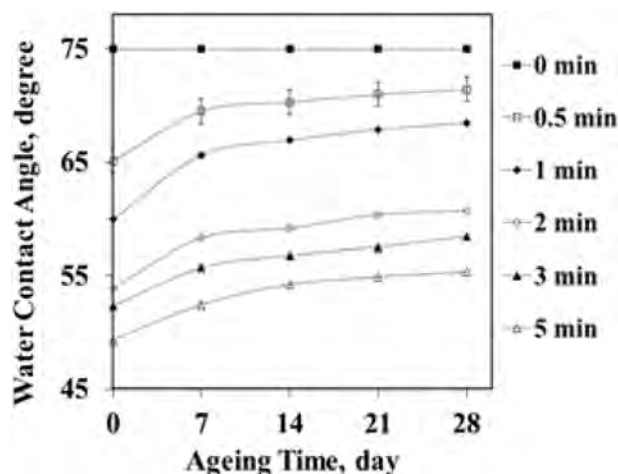

Fig. 7. WCA of untreated and air-plasma treated CSPCL films during ageing.

3.3.1. Ageing effect

The ageing study reveals that the changes occurred during plasma treatment gets reverted to some extent, over the period of storage time. The causes of hydrophobic recovery includes presence of additives and finishing aids in polymer, diffusion of low molecular weight oligomers into the bulk as surface modification is limited to very thin layer, thermodynamic thrust of modified surface force hydrophilic groups to move in bulk in order to attain

more stable state [46]. The ageing study was performed with respect to water contact angle (WCA) for 7, 14, 21 and 28 days stored in dry condition. As seen from Fig. 7, the WCA increases with ageing time in case of air-plasma treated samples.

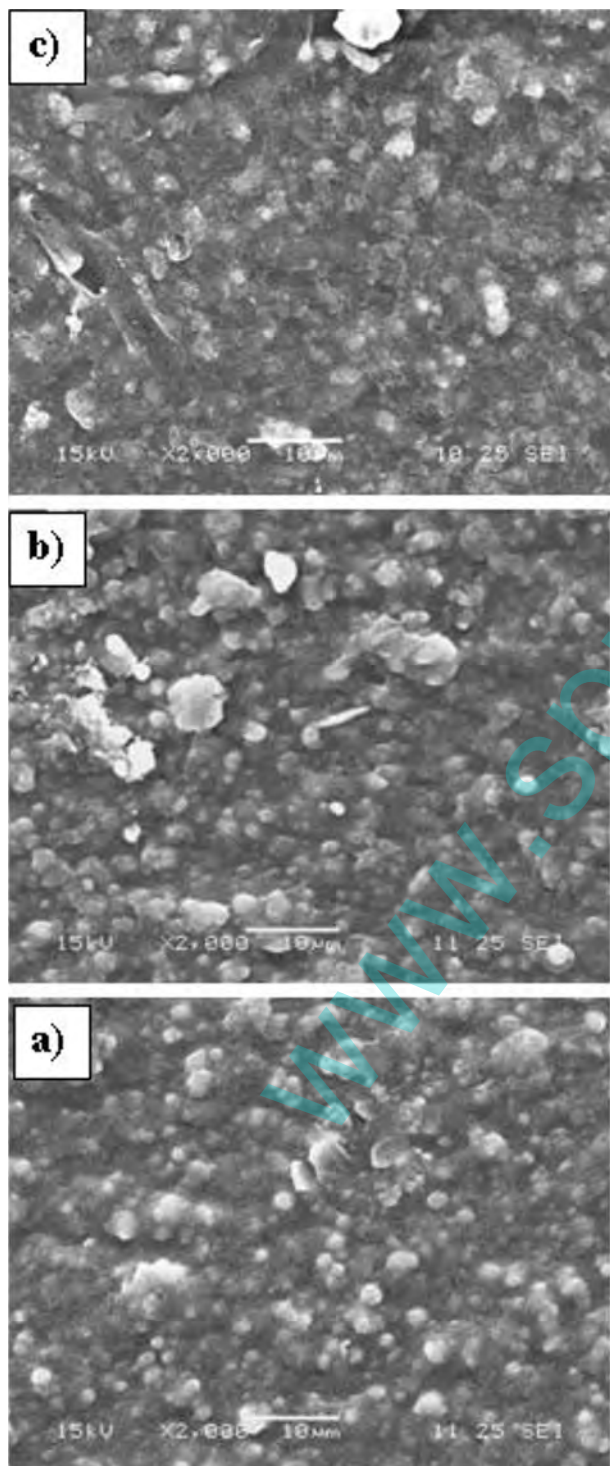

Fig. 8. SEM (2000x) of CSPCL films a) untreated, b) 2 min air-plasma treated and c) 5 min air-plasma treated.

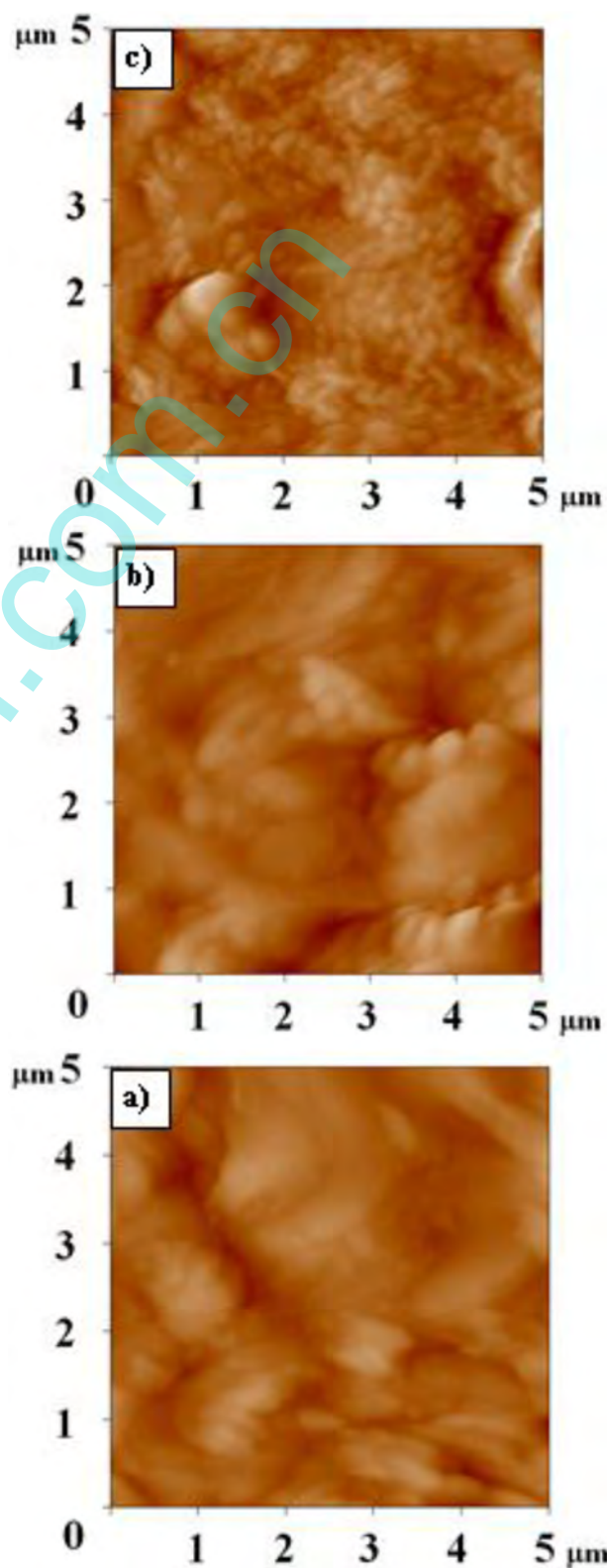

Fig. 9. AFM of CSPCL films a) untreated, b) 2 min air-plasma treated and c) 5 min air-plasma treated.

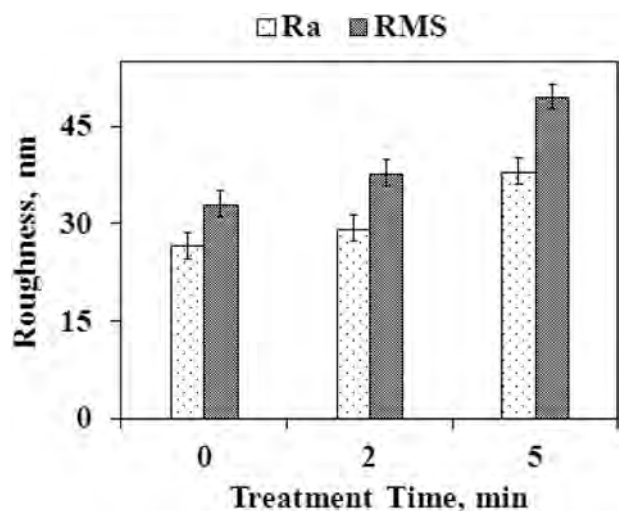

Fig. 10. Ra and RMS roughness of untreated and air-plasma treated CSPCL films.

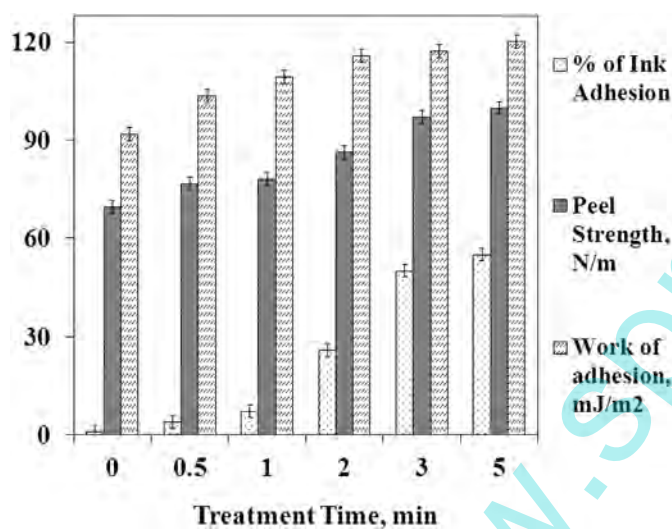

Fig. 11. percentage of ink adhesion and peel strength of untreated and air-plasma treated CSPCL films.

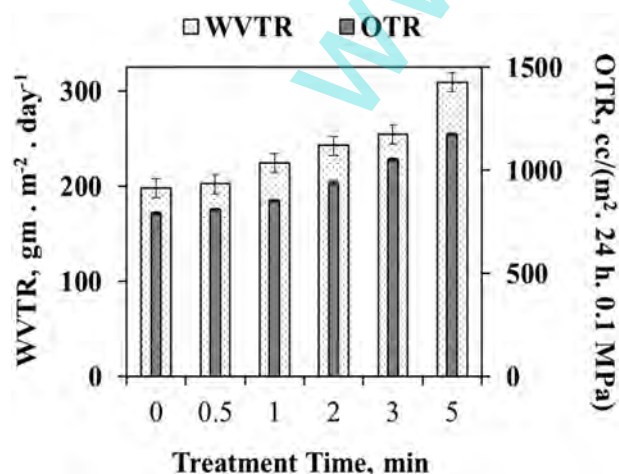

Fig. 12. WVTR and OTR of untreated and air-plasma treated CSPCL films.

It was observed that, for short duration of treatment (0.5 min and 1 min), hydrophobic recovery is higher than that of longer duration of treatment (2 min onwards). It was found that for 5 min air-plasma treatment O/C ratio increases to 24.29% and increase in polarity is 23.01%. Thus higher treatment time induces large concentration of polar groups. Hence hydrophilic character introduced by long duration of air-plasma treatment preserved for longer ageing time. This was in agreement with Lawton et al. [47]. Shorter duration of treatment time incorporates functional groups without much changing surface morphology whereas longer duration of plasma treatment causes chain scission, breaking of bonds and thus introducing polar functional groups along with increase in effective surface area by etching. The surface roughness is a permanent change. It is well known that contact angle decreases on rougher surfaces as it facilitates spreading of liquid onto the surface. Therefore, hydrophobic recovery is less for the samples treated for more than 2 min.

3.4. Surface morphology

Morphological changes in untreated and air-plasma treated CSPCL films can be seen from SEM and AFM images, Fig. 8 and Fig. 9 respectively.

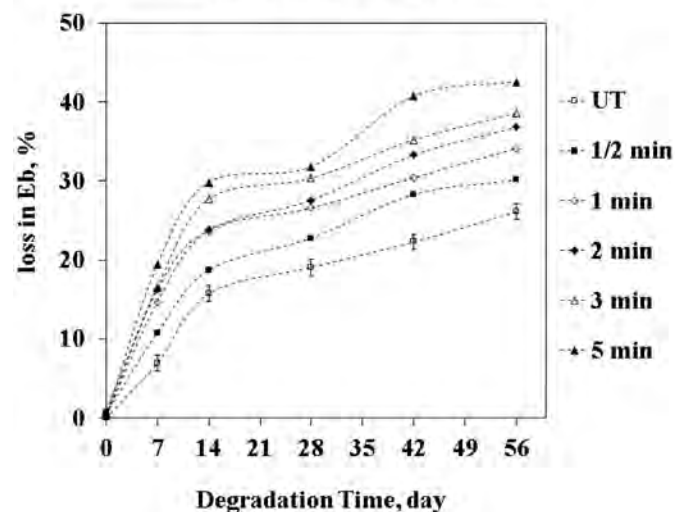
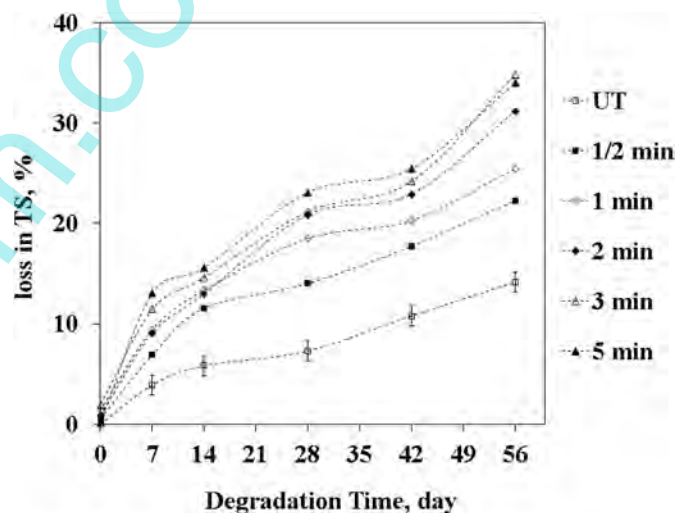

Fig. 13. Loss in TS (%) and loss in Eb (%) of untreated and air-plasma treated CSPCL films in indoor soil burial method.

The CSPCL films used in this study have 30% starch (minor phase), 65% PCL (major phase) and 5% other materials as additives. With increasing treatment time the minor phase (i.e. starch) is getting etched out. This explains the relative increase of C=O peak, C–H peaks in ATR-FTIR of air-plasma treated samples. AFM images show increase in nodular structure with respect to treatment time, which contribute to increasing roughness. Fig. 10 shows Ra and RMS roughness of untreated and air-plasma treated samples. It was found that with increasing treatment time, Ra and RMS both were increasing from 10.15% and 14.55% for 2 min air-plasma to 30.18% and 33.47% for 5 min air-plasma treatment respectively.

3.5. Adhesion properties–peel strength and printability

Adhesion properties are surface related properties and play an important role in packaging field. Plasma surface modifications do influence adhesion properties. The effect of air-plasma treatment on adhesion properties of CSPCL polymer surface is studied from peel strength and printability. Fig. 11 shows peel strength and percent of ink adhesion (printability) of untreated and air-plasma treated CSPCL films.

With increase in air-plasma treatment time, peel strength and printability both are found to be increasing. The factors influencing adhesion mainly includes physical and chemical aspects. As seen before, plasma treatment results in surface cleaning and ablation as well as rougher morphology. These physical processes remove low molecular weight fragments which in effect reduce the formation of weak boundary layer and increases effective surface area of substrate. Polar functionalities introduced on surface increases wettability and hence chemical interaction between surface and adhesive/ink is increased. All these factors contribute to stronger joint. It can be seen in Fig. 11 that both, percentage ink of adhesion and peel strength are proportional to the work of adhesion (calculated from WCA data, the procedure is described elsewhere [48]) and found to be increasing with plasma treatment time.

3.6. Barrier properties–WVTR and OTR

Barrier properties are of importance for any packaging material. WVTR and OTR were studied to check whether there is any adverse effect of air-plasma treatment on barrier properties of CSPCL films. There is no change in barrier properties for first 0.5 min plasma treatment as it causes plasma cleaning only. After the plasma cleaning ablation and etching of surface begins. Therefore, we observed slight increase in water vapour and oxygen transmission rate for 2 min air-plasma treated samples as shown in Fig. 12.

At higher duration of plasma treatment time (5 min), due to etching effect (as seen from weight loss study Fig. 2) the penetration of water vapour and oxygen molecules becomes easy and thus results in poor barrier properties. Less ageing effect is observed for samples treated for 2 min and above. Similarly, other properties studied did show good improvement for the samples treated for 2 min in air-plasma. Therefore, 2 min of plasma treatment time can be considered as optimum as there is marginal loss in barrier properties. For packaging of electronics items, pharmaceuticals and crispy food items such as biscuits, we need to have excellent barrier properties. Hence short duration (0.5–1 min) of air-plasma treatment would be suitable for such packaging. On the contrary, materials having poor barrier properties would be preferred for the packaging of fruits and vegetables as they need ventilation. Certain gases are released by fruits and vegetables during storage. In such cases, long duration (5 min) of air-plasma treatment can be advised which improves other surface properties as well. Thus depending upon the material to be packed, plasma treatment time can be adjusted.

3.7. Biodegradation study

3.7.1. Degradation studies with indoor soil burial method

Studies conducted in conditions simulating natural environment using indoor soil burial method of the samples provides a real

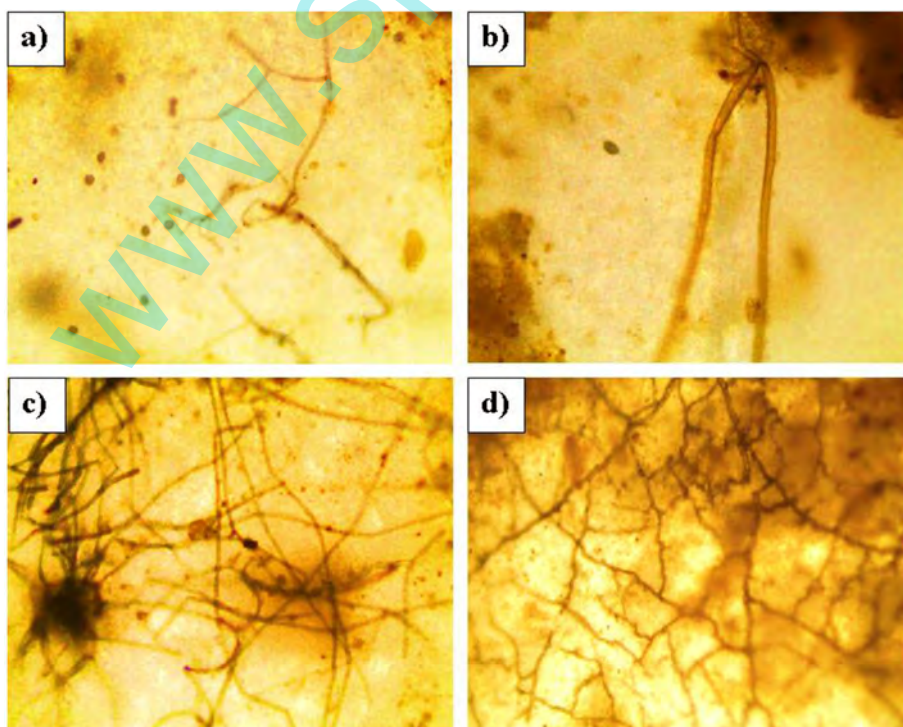

Fig. 14. OLM images (40 \times) of untreated CSPCL films soiled for a) 14 days b) 56 days and 5 min air-plasma treated CSPCL films soiled for c) 14 days d) 56 days.

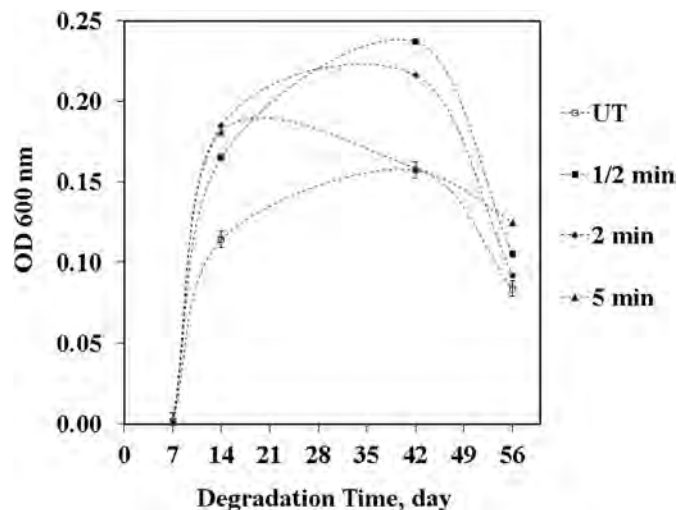

Fig. 15. OD600 nm for untreated and air-plasma treated CSPCL films exposed to BS 121 through 56 days.

picture of the degradation of polymers in nature because of the similarity to onsite conditions of use and disposal. The microorganisms present in the soil use the polymer material as a source of carbon for their growth thereby degrading the polymer. Degradation of polymer was indicated by the alterations in its mechanical properties which included loss in tensile strength (TS) and % Elongation at break (Eb). The loss in TS (%) and loss in Eb (%) of samples un-soiled (0 day) and soiled (7, 14, 28, 42 and 56 days) was calculated with respect to untreated and un-soiled CSPCL film and listed in Fig. 13.

It is observed that unsoiled air-plasma treated CSPCL films show marginal loss of tensile properties. Highest (5 min) air-plasma treatment resulted in loss of 1.54% and 0.53% in TS and Eb respectively. When untreated and air-plasma treated samples were soiled

up to 56 days, significant loss of tensile properties was observed [39,49]. It can be seen that % loss in Eb was more than that of % TS. An increasing trend in the % loss in TS and % loss in Eb is observed with increasing time of air-plasma treatment. The 5 min air-plasma treatment resulted in 34% loss of TS and 42% loss of Eb by day 56.

Optical light microscope (OLM) images (40 \times) of untreated and 5 min air-plasma treated CSPCL films soiled for 14 and 56 days showed remarkable growth of microbial flora on 5 min air-plasma treated sample surface as compared to untreated samples (Fig. 14). Rapid colonization by fungi was observed along with bacterial colonization.

3.7.2. Degradation studies with BS 121

Turbidimetric studies of CSPCL films treated for 0.5, 2, 5 min and exposed to BS121 through 56 days showed the lag, log, stationary and death phases of microorganisms used (Fig. 15). The increase in turbidity indicates growth of BS 121 in correlation to increase in biodegradation. OLM images (Fig. 16) reveal changes in visual appearance of surfaces exposed to BS 121 for day 7, day 14 and day 56 as compared to unexposed surface. These changes in visual appearance were attributed to colonization and adhesion of BS 121 on sample surface. An increasing trend in colonization and adhesion of BS 121 was observed throughout the study was in agreement with turbidimetric studies.

The SEM images (Fig. 17) of day 56 of untreated and air-plasma treated CSPCL films, exposed to BS 121 show remarkable increase in perforations and fine lines/cracks with increase in air-plasma treatment. These changes on surface of samples were indicative of microbial degradation. It can be seen that plasma treated samples (Fig. 17b and c) showed enhanced microbial activity suggesting enhanced degradation than that of untreated sample (Fig. 17a).

As seen from above observed results, untreated CSPCL film was hydrophobic, smooth as compared to air-plasma treated films. Hence, adhesion and growth of BS 121, as seen in OLM images (Fig. 18), on untreated CSPCL film was limited as compared to air-plasma treated CSPCL films. Thus, air-plasma treatment aided in

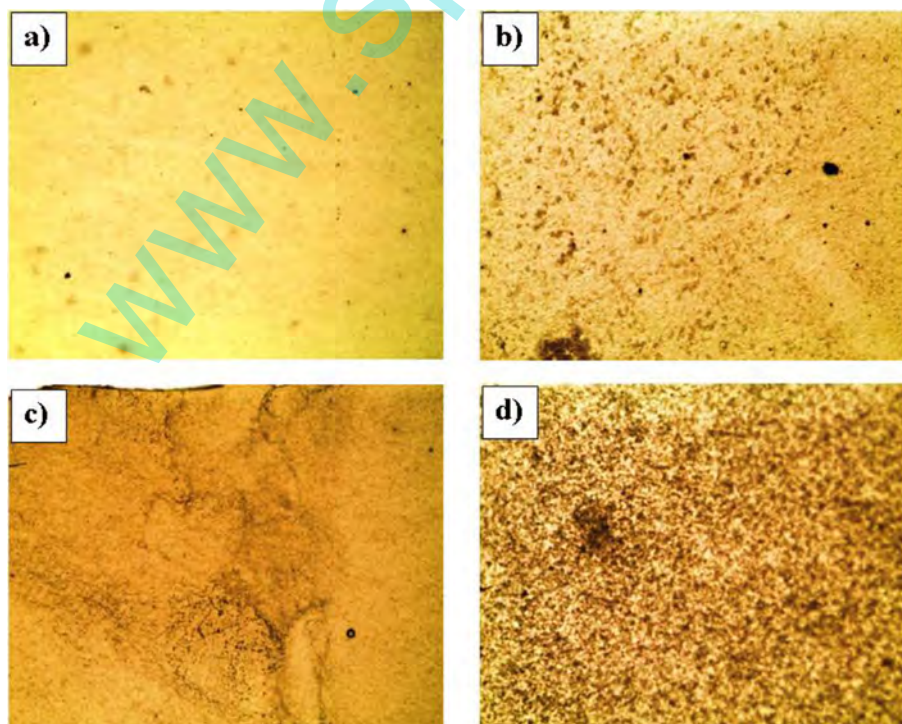

Fig. 16. OLM images of 5 min air-plasma treated CSPCL film a) not exposed to BS 121 and exposed to BS 121 for b) 7 days, c) 14 days and d) 56 days.

microbial colonization and subsequent biodegradation of polymer.

4. Conclusion

Considering the role of synthetic polymers as a packaging material and its impact on environment, a biodegradable polymer is

one of the solutions. Air-plasma treatment results in improved surface properties like wettability, adhesion, printability through the incorporation of polar functional groups and roughness. Shorter duration of plasma treatment time does not hamper the barrier properties of the CSPCL films. Air-plasma treatment of short duration up to 2 min modifies surface properties suitably. Therefore short duration air-plasma treated CSPCL film can effectively be used for packaging application (without affecting its original barrier properties) with improved degradation properties while reducing

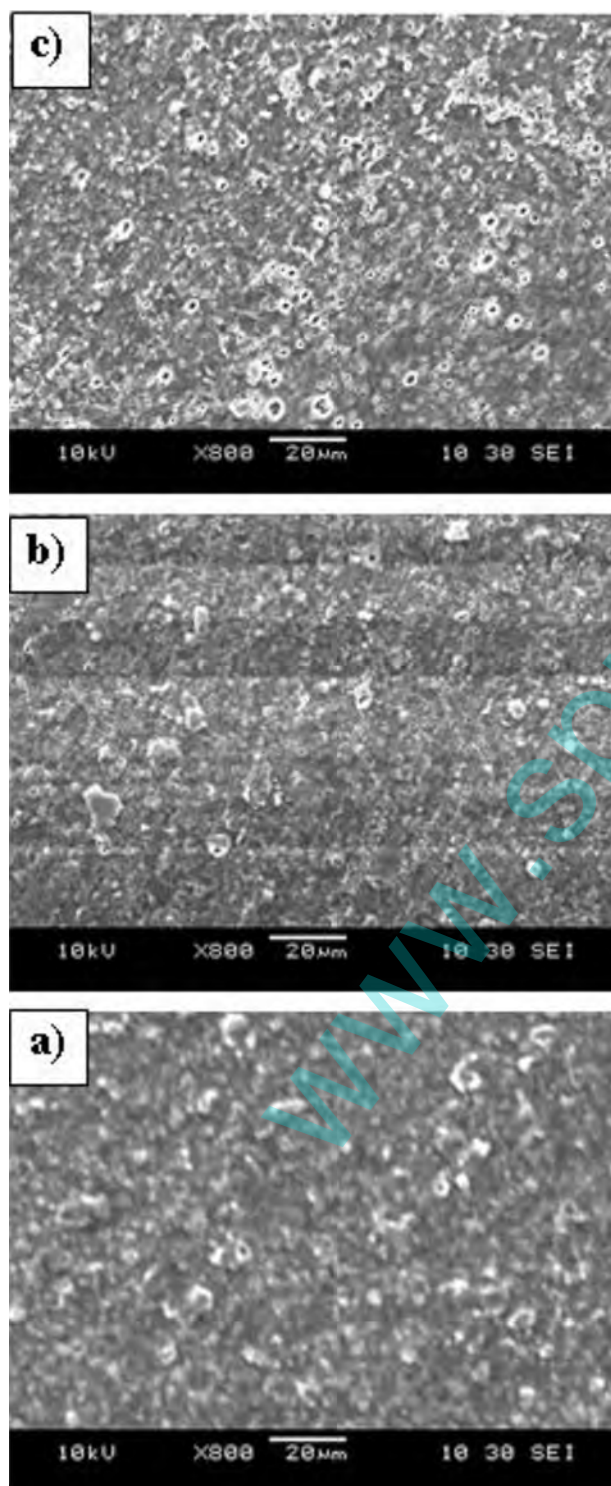

Fig. 17. SEM images of CSPCL samples exposed to BS 121 for 56 days. a) Untreated, b) 2 min air-plasma and c) 5 min air-plasma.

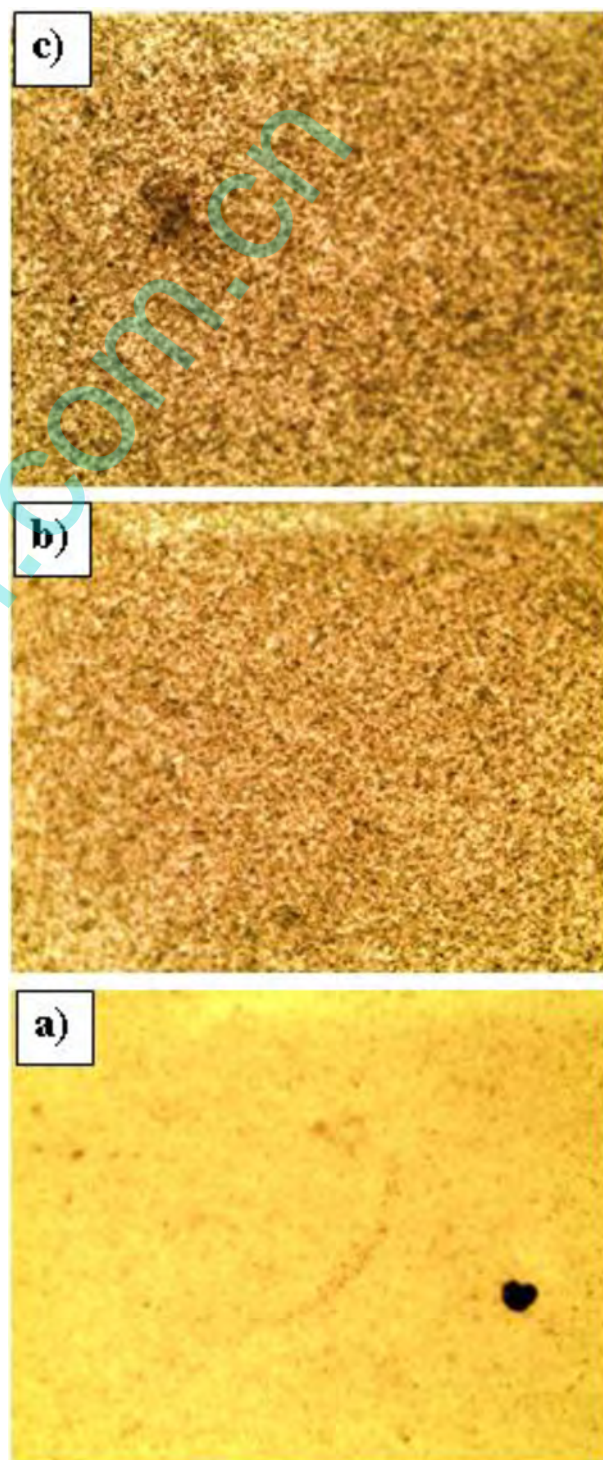

Fig. 18. OLM images of CSPCL samples exposed to BS 121 for 56 days a) untreated, b) 2 min air-plasma and c) 5 min air-plasma.

the load on environment. However, sometimes inducing poor barrier properties in the packaging material would be advantageous, particularly for packaging of fruits and vegetables. Depending upon the requirement of the material to be packed, one can select plasma treatment time. Such air-plasma treated CSPCL films when exposed to soil and bacterial environment; it enhances adhesion and growth of micro-organisms due to hydrophilic and rougher surface; and undergoes degradation in presence of microbial flora available in the environment. Thus air-plasma processing of CSPCL films seems to be an attractive option for biodegradable polymers found useful for packaging applications and improving biodegradation.

Acknowledgement

The author G. A. Arolkar wishes to acknowledge University Grants Commission (UGC), India for the support provided through UGC-SAP fellowship. The author Salgo M. Jacob also wishes to acknowledge UGC for the award of JRF.

References

- [1] S. Ebnasajjad, Handbook of Biopolymers and Biodegradable Plastics – Properties, Processing, and Applications, Elsevier Inc, Oxford, 2013.
- [2] G.E. Luckachan, C.K.S. Pillai, Biodegradable polymers– a review on recent trends and emerging perspectives, *J. Polym. Environ.* 19 (2011) 637–676.
- [3] J.E. Potts, R.A. Clendinning, W.B. Ackart, An Investigation of the Biodegradability of Packaging Plastics, U.S. Environmental Protection Agency, Washington, DC, 1972, pp. 22–24.
- [4] J.V. Koleske, Blends containing poly(ϵ -caprolactone) and related polymers, in: D.R. Paul, S. Newman (Eds.), *Polymer Blends*, Academic Press, New York, 1978, pp. 369–389.
- [5] X.-L. Wang, K.-K. Yang, Y.-Z. Wang, Properties of starch blends with biodegradable polymers, *J. Macromol. Sci. Part C* 43 (2003) 385–409.
- [6] C.-S. Wu, Physical properties and biodegradability of maleated-polycaprolactone/starch composite, *Polym. Degrad. Stab.* 80 (2003) 127–134.
- [7] C.R. di Franco, V.P. Cyrus, J.P. Busalmen, R.A. Ruseckaite, A. Vazquez, Degradation of polycaprolactone/starch blends and composites with sisal fibre, *Polym. Degrad. Stab.* 86 (2004) 95–103.
- [8] A. de Campos, G.H.D. Tonoli, J.M. Marconcini, L.H.C. Mattoso, A. Klaczynski, K.S. Gregorski, et al., TPS/PCL composite reinforced with treated sisal fibers: property, biodegradation and water-absorption, *J. Polym. Environ.* 21 (2013) 1–7.
- [9] A. Taghizadeh, B.D. Favis, Carbon nanotubes in blends of polycaprolactone/thermoplastic starch, *Carbohydr. Polym.* 98 (2013) 189–198.
- [10] V.B. Carmona, A.C. Correa, J.M. Marconcini, L.H.C. Mattoso, Properties of a biodegradable ternary blend of thermoplastic starch (TPS), poly(ϵ -Caprolactone) (PCL) and poly(lactic acid) (PLA), *J. Polym. Environ.* 23 (2015) 83–89.
- [11] S. Selke, in: *Biodegradation and Packaging: a Literature Review*, second ed., Pira International, 1996.
- [12] F. Garbassi, M. Morra, E. Occhiello, *Polymer Surfaces—from Physics to Technology*, John Wiley & Sons, New York, 1998, pp. 233–288.
- [13] R.R. Deshmukh, N.V. Bhat, Pretreatments of textiles prior to dyeing: plasma processing, in: P. Hauser (Ed.), *Textile Dyeing*, In Tech Publisher, 2011, pp. 33–56.
- [14] N.V. Bhat, R.R. Deshmukh, Plasma processing of textiles to enhance their dyeing and surface properties, in: S.K. Nema, P.B. Jhala (Eds.), *Plasma Technologies for Textile and Apparel*, Woodhead Publishing India, 2014, pp. 189–230.
- [15] T. Desmet, R. Morent, N.D. Geyter, C. Leys, E. Schacht, P. Dubrue, Nonthermal plasma technology as a versatile strategy for polymeric biomaterials surface modification: a review, *Biomacromolecules* 10 (2009) 2351–2378.
- [16] D. Demirgoz, C. Elvira, J.F. Mano, A.M. Cunha, E. Piskin, R.L. Reis, Chemical modification of starch based biodegradable polymeric blends: effects on water uptake, degradation behaviour and mechanical properties, *Polym. Degrad. Stab.* 70 (2000) 161–170.
- [17] A. Campos, J.M. Marconcini, S.M. Martins-Franchetti, L.H.C. Mattoso, The influence of UV-C irradiation on the properties of thermoplastic starch and polycaprolactone biocomposite with sisal bleached fibers, *Polym. Degrad. Stab.* 97 (2012) 1948–1955.
- [18] C. Choong, S. Yuan, E.S. Thian, A. Oyane, J. Triffitt, Optimization of poly(ϵ -caprolactone) surface properties for apatite formation and improved osteogenic stimulation, *J. Biomed. Mater. Res. Part A* 100A (2012) 353–361.
- [19] R.R. Deshmukh, A.R. Shetty, Surface characterization of polyethylene films modified by gaseous plasma, *J. Appl. Polym. Sci.* 104 (2007) 449–457.
- [20] R.R. Deshmukh, N.V. Bhat, The mechanism of adhesion and printability of plasma processed PET films, *Mater. Res. Innovations* 7 (2003) 283–290.
- [21] S. Siri, P. Wadbuva, V. Amornkitbamrung, N. Kampa, S. Maensiri, Surface modification of electrospun PCL scaffolds by plasma treatment and addition of adhesive protein to promote fibroblast cell adhesion, *Mater. Sci. Technol.* 26 (2010) 1292–1297.
- [22] H. Shan-hui, L. Chen-Huan, T. Ching-Shiow, Air plasma treated chitosan fibers-stacked scaffolds, *Biofabrication* 4 (2012) 015002.
- [23] S. de Valence, J.-C. Tille, C. Chaabane, R. Gurny, M.-L. Bochaton-Piallat, B.H. Walpoth, et al., Plasma treatment for improving cell biocompatibility of a biodegradable polymer scaffold for vascular graft applications, *Eur. J. Pharm. Biopharm.* 85 (2013) 78–86.
- [24] H. Deplaine, M. Lebourg, P. Ripalda, A. Vidaurre, P. Sanz-Ramos, G. Mora, et al., Biomimetic hydroxyapatite coating on pore walls improves osteointegration of poly(L-lactic acid) scaffolds, *J. Biomed. Mater. Res. Part B Appl. Biomater.* 101B (2013) 173–186.
- [25] W. Kai, S. Iwamoto, K. Akamatsu, S. Nakao, A. Isogai, T. Iwata, Enhanced interlayer interaction in cellulose single nanofibre and poly(L-lactic acid) layered films by plasma-initiated surface grafting of poly(acrylic acid) onto poly(L-lactic acid) films, *Polym. Degrad. Stab.* 95 (2010) 1004–1010.
- [26] J. Zhang, K. Kasuya, A. Takemura, A. Isogai, T. Iwata, Properties and enzymatic degradation of poly(acrylic acid) grafted polyhydroxyalkanoate films by plasma-initiated polymerization, *Polym. Degrad. Stab.* 98 (2013) 1458–1464.
- [27] A. Jorda-Vilaplana, V. Fombuena, D. Garcia-Garcia, M.D. Samper, L. Sanchez-Nacher, Surface modification of polylactic acid (PLA) by air atmospheric plasma treatment, *Eur. Polym. J.* 58 (2014) 23–33.
- [28] S.K. Pankaj, C. Bueno-Ferrer, N.N. Misra, L. O'Neill, A. Jimenez, P. Bourke, et al., Characterization of polylactic acid films for food packaging as affected by dielectric barrier discharge atmospheric plasma, *Innovative Food Sci. Emerg. Technol.* 21 (2014) 107–113.
- [29] F.M. Fowkes, Attractive forces at interfaces, *Ind. Eng. Chem.* 56 (1964) 40–52.
- [30] D.K. Owens, R.C. Wendt, Estimation of the surface free energy of polymers, *J. Appl. Polym. Sci.* 13 (1969) 1741–1747.
- [31] D.H. Kaelble, Dispersion-polar surface tension properties of organic solids, *J. Adhesion* 2 (1970) 66–81.
- [32] W. Rabel, Einige Aspekte der Benetzungstheorie und ihre Anwendung auf die Untersuchung und Veränderung der Oberflächeneigenschaften von Polymeren, *Farbe Lacke* 77 (1971) 997–1005.
- [33] R.R. Deshmukh, M.K. Malik, A method for estimating interfacial tension of liquid crystal embedded in polymer matrix forming PDLC, *J. Appl. Polym. Sci.* 131 (2014).
- [34] T. Hirotsu, A.A.J. Ketelaars, K. Nakayama, Biodegradation of poly(ϵ -caprolactone)-polycarbonate blend sheets, *Polym. Degrad. Stab.* 68 (2000) 311–316.
- [35] S.-H. Hsu, C.-M. Tang, C.-C. Lin, Biocompatibility of poly(ϵ -caprolactone)/poly(ethylene glycol) diblock copolymers with nanophase separation, *Biomaterials* 25 (2004) 5593–5601.
- [36] D. Rohindra, P. Sharma, J. Khurma, Soil and microbial degradation study of poly(ϵ -caprolactone) – poly(vinyl butyral) blends, *Macromol. Symp.* 224 (2005) 323–332.
- [37] R. Balkova, S. Hermanova, S. Voberkova, P. Damborsky, L. Richtera, J. Omelkova, et al., Structure and morphology of microbial degraded poly(ϵ -caprolactone)/graphite oxide composite, *J. Polym. Environ.* 22 (2014) 190–199.
- [38] T. Corrales, I. Larraza, F. Catalina, T. Portoles, C. Ramirez-Santillan, M. Matesanz, et al., Vitro biocompatibility and antimicrobial activity of poly(ϵ -caprolactone)/montmorillonitenanocomposites, *Biomacromolecules* 13 (2012) 4247–4256.
- [39] C. Bastioli, A. Cerutti, I. Guanella, G.C. Romano, M. Tosin, Physical state and biodegradation behavior of starch-polycaprolactone systems, *J. Environ. Polym. Degrad.* 3 (1995) 81–95.
- [40] Biodegradation behaviour of polymers in the soil, in: C. Bastioli (Ed.), *Handbook of Biodegradable Polymers*, Shawbury, Rapra Technology Limited, 2005, pp. 57–102.
- [41] http://www.epa.gov/biotech_rule/pubs/fra/fra009.htm.
- [42] H. Yasuda, Glow discharge polymerization, *J. Polym. Sci. Macromol. Rev.* 16 (1981) 199–293.
- [43] I. Junkar, U. Cvelbar, A. Vesel, N. Hauptman, M. Mozetič, The role of crystallinity on polymer interaction with oxygen plasma, *Plasma Process. Polym.* 6 (2009) 667–675.
- [44] B. Gupta, J. Hilborn, C. Hollenstein, C.J.G. Plummer, R. Houriet, N. Xanthopoulos, Surface modification of polyester films by RF plasma, *J. Appl. Polym. Sci.* 78 (2000) 1083–1091.
- [45] G. Beamson, D. Briggs, *High Resolution XPS of Organic Polymers: the Scienta ESCA300 Database*, John Wiley & Sons, New York, 1992.
- [46] F. Garbassi, M. Morra, E. Occhiello, *Polymer Surfaces—from Physics to Technology*, John Wiley & Sons, New York, 1998, pp. 317–349.
- [47] R.A. Lawton, C.R. Price, A.F. Runge, W.J. Doherty III, S.S. Saavedra, Air plasma treatment of submicron thick PDMS polymer films: effect of oxidation time and storage conditions, *Colloids Surfaces A Physicochem. Aspects* 253 (2005) 213–215.
- [48] R.R. Deshmukh, A.R. Shetty, Comparison of surface energies using various approaches and their suitability, *J. Appl. Polym. Sci.* 107 (2008) 3707–3717.
- [49] P. Chunghee, K. Soomin, S. Huensup, I. Seung-soon, Effect of oxygen plasma treatment on the hydrophilicity and biodegradability of poly(butylene succinate), *AATCC Rev.* 6 (2006) 38–42.